

GLOBO

Inspired by **Life**

News **19** Collections

04. Le Pietre nuove finiture *new finishes / neue Oberflächen*

12. T-Edge

14. New Genesis

16. Stone 45 SENZABRIDA® / *No rim / Spülrandlos*

18. Grace SENZABRIDA® / *No rim / Spülrandlos*

20. DOCCIATRE

**IL PIACERE
DELLA MATERIA**
*THE PLEASURE
OF MATTER*
*DIE BEGEISTERUNG
AM MATERIAL*



A Peperino e Travertino, tipiche del territorio viterbese, e alla più recente Marmo di Carrara, si aggiungono ora undici nuove finiture materiche ad effetto pietra: Arabescato Grigio, Arabescato Brown, Arabescato Chiaro, Striato Beige, Striato Grigio, Graniglia Beige, Graniglia Ghiaccio, Graniglia Verde, Graniglia Turchese, Portoro Nero e Portoro Marrone.

Eleven new textural finishes inspired by the most beautiful natural stones have now been added to the Peperino and Travertino finishes, traditional stones of central Italy, and the more recent Marmo di Carrara finish: Arabescato Grigio, Arabescato Brown, Arabescato Chiaro, Striato Beige, Striato Grigio, Graniglia Beige, Graniglia Ghiaccio, Graniglia Verde, Graniglia Turchese, Portoro Nero e Portoro Marrone.

Elf neue Oberflächenveredelungen, inspiriert von den schönsten Natursteinen, wurden zu den bestehenden Oberflächen Peperino und Travertino, traditionelle Natursteine aus Mittelitalien, und der neueren Oberfläche Carrara Marmor, ergänzt: Arabescato Grigio, Arabescato Brown, Arabescato Chiaro, Striato Beige, Striato Grigio, Graniglia Beige, Graniglia Ghiaccio, Graniglia Verde, Graniglia Turchese, Portoro Nero e Portoro Marrone.



◀
B6R63AC
61.37



Finitura Graniglia *Graniglia finish*

I candidi e preziosi marmi bianchi richiamano alla mente gli sfarzi dell'epoca classica, in contrasto con le venature scure e arabescate. Molto suggestive ed eleganti, le varianti più scure sono invece ideali per creare un piacevole contrasto con contesti moderni. Le pietre granigliate tipiche della tradizione italiana, spesso scelte per progetti residenziali estremamente moderni, si sposano con ambienti bagno dalle linee essenziali.

The purity of prized white marble recalls the splendour of the classical ages, while creating a contrast with the dark arabesques of its veins. Particularly evocative and elegant, the darker variants are ideal for creating a pleasing contrast with modern interiors. The terrazzo stones typical of the Italian tradition, often selected for extremely modern residential projects, team up perfectly with bathrooms of more austere lines.



B6R63GB
61.37

Die reinen und kostbaren weißen Marmore erinnern an den Prunk der klassischen Epoche, im Gegensatz zu den dunklen und mit Arabesken verzierten Maserungen. Sehr suggestiv und elegant sind hingegen die dunkleren Varianten, die ideal sind, um angenehme Kontraste und modernes Ambiente zu schaffen. Die für die italienische Tradition typischen Sandsteine, die häufig für extrem moderne Wohnprojekte ausgewählt werden, verbinden sich perfekt in Bädern mit markanten Linien



B6O54AG
54.36

B6O60AB
60.41

B6T37AC
Ø 37



Finitura Striato *Striato finish*



B6R60SG
60.38



B6R63SB
61.37



Finitura Portoro *Portoro finish*

Ricerca e innovazione sono alla base degli sviluppi di una gamma di prodotti in continua evoluzione, che trae ispirazione dalle venature delle pietre più pregiate per offrire soluzioni estetiche e funzionali che possano andare incontro alle esigenze di una clientela ampia e diversificata.

Research and innovation are the cornerstone of developing and constantly honing a product range inspired by the veins seen in the most sought-after natural stone in order to offer attractive and practical solutions for every need.

Forschung und Innovation sind die Grundlage der Entwicklungen einer Produktpalette in kontinuierlicher Evolution, die aus den Äderungen der kostbarsten Steine Inspiration zieht, um ästhetische und funktionelle Lösungen anzubieten, die den Ansprüchen einer ambitionierten und vielseitigen Kundschaft entgegenkommen.



Finitura Marmo di Carrara *Marmo di Carrara finish*



B6060MC
60.41



Finitura Travertino *Travertino finish*

Le preziose venature che spaziano dal bianco, al grigio scuro fino a quelle dorate, la finezza dei suoi colori e l'esclusivo fulgore rendono le pietre naturali l'ispirazione ideale per la collezione di finiture materiche di Ceramica Globo, che si amplia con l'inserimento di nuove proposte ispirate a marmi e pietre granigliate molto diverse tra loro.

Precious veining ranging from white to dark grey and gilt, the elegance of the colour palette and the exclusiveness of its splendour make natural stones the ideal inspiration for the Ceramica Globo collection of textural finishes, now further extended to include new solutions inspired by highly differentiated marbles and natural stones.

Die wertvollen Maserungen, die von weiß, über dunkelgrau bis zu goldfarbenen reichen, die Feinheit der Farben und der exklusive Glanz macht die Natursteine zur idealen Inspiration für die Kollektion (Le Pietre) der Oberflächenveredelung von, die sich an unterschiedlichsten Marmor- und Sandsteinen inspirieren, erweitert. Ceramica Globo. Diese Kollektion wird durch neue Oberflächen, die sich an unterschiedlichsten Marmor- und Sandsteinen inspirieren, erweitert.



B6054TR
54.36

Finitura Peperino Grigio *Peperino Grigio finish*



FO061PG
60.35

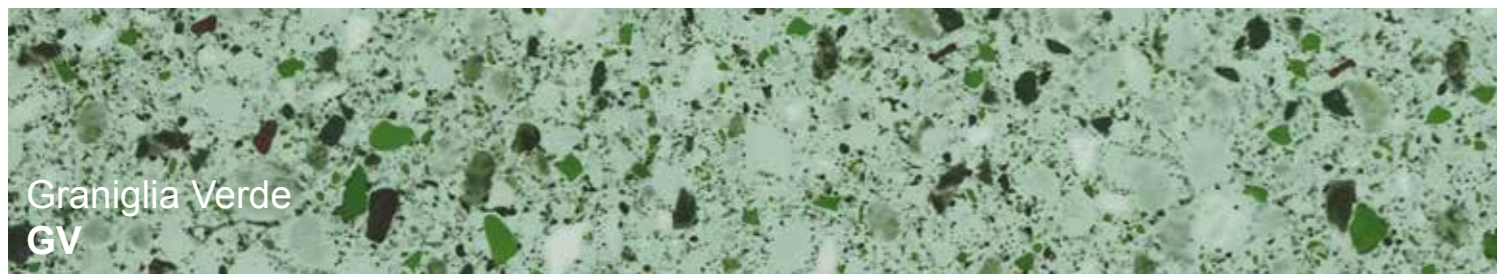

Graniglia Verde
GV



Striato Beige
SB

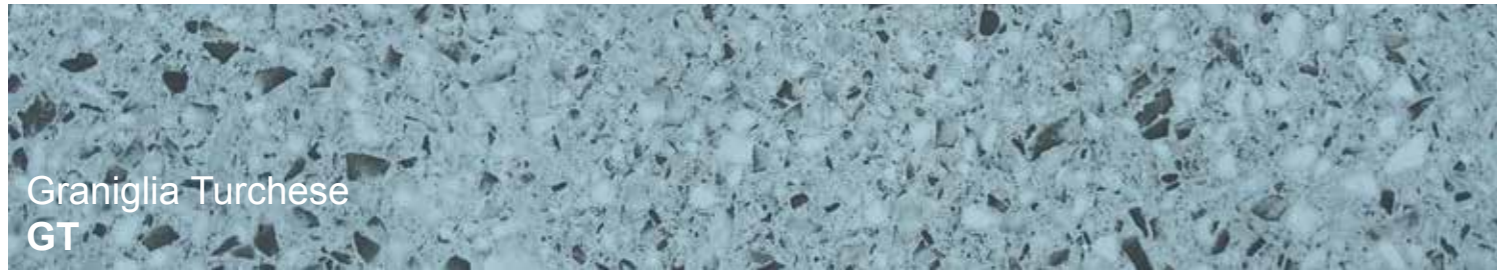

Graniglia Turchese
GT



Striato Grigio
SG

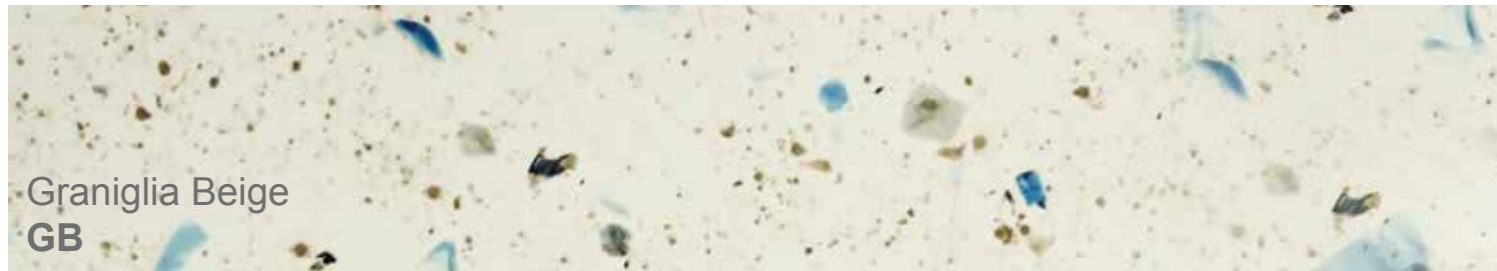

Graniglia Beige
GB

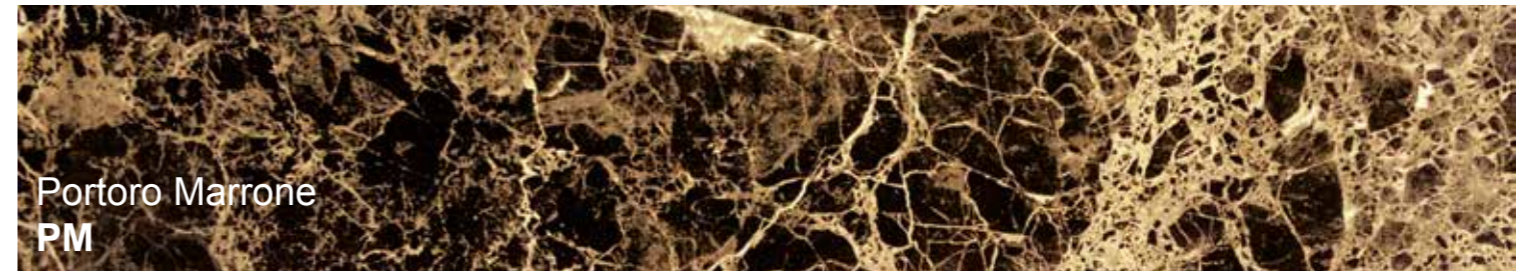

Portoro Marrone
PM

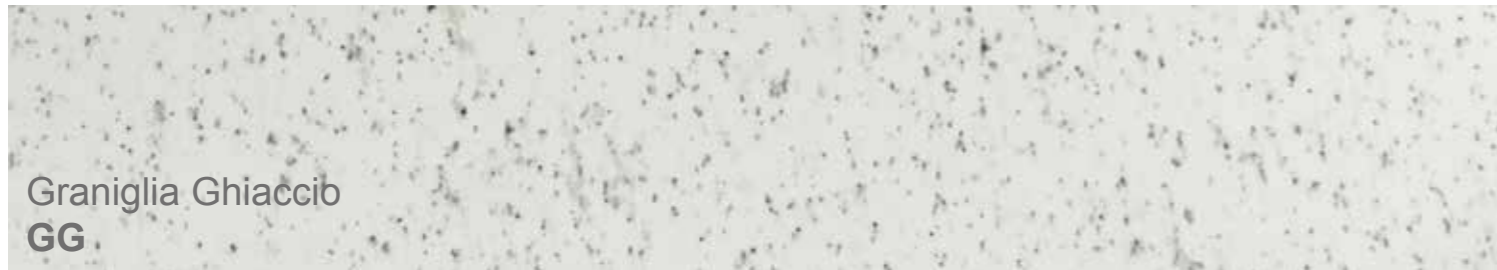

Graniglia Ghiaccio
GG



Portoro Nero
PN



Arabescato Brown
AB



Marmo di Carrara
MC



Arabescato Chiaro
AC



Travertino
TR



Arabescato Grigio
AG

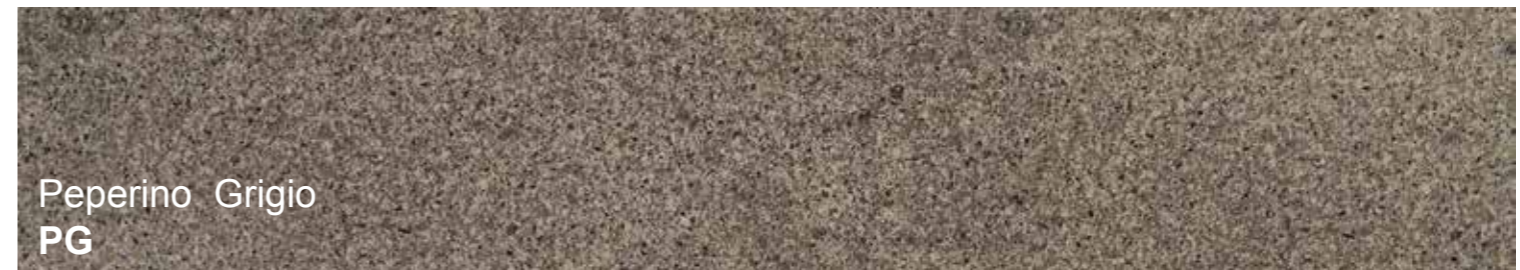

Peperino Grigio
PG

T-Edge 47

by CreativeLab+



◀ B6R51BI
50.47

▶ B6R65BI
60.47

▲ B6R80BI
80.47

La collezione T-Edge, disegnata da CreativeLab+ per Globo, si arricchisce di nuove combinazioni e modelli, a conferma degli ottimi riscontri ricevuti. Punto forte della collezione, disponibile nei 14 colori ceramici di Bagno di Colore, sono i bordi sottili ottenuti grazie all'introduzione del nuovo impasto brevettato Globothin®, capace di garantire, a fronte di spessori ridotti, più durezza e maggiore brillantezza.

Following the excellent market acceptance, Globo has added more combinations and models to its T-Edge Collection, designed by CreativeLab+ for Globo. The real highlight of the T-Edge collection, available in the 14 Bagno di Colore ceramic shades, are the super slim edges – 6 mm thick – made possible by the new patented GLOBOTHIN® ceramic mixture, which guarantees reduced thickness along with greater strength and shine.

Die Kollektion T-Edge, die von CreativeLab+ für Globo entworfen wurde, ist durch neue Kombinationen und Modelle erweitert worden, als Antwort auf die herausragende Marktakzeptanz der bestehenden Kollektion. Das Highlight dieser Waschtisch-Serie, die in 14 Keramikfarben in Bagno di Colore erhältlich ist, sind die hauchdünnen Kanten von nur 6 mm - dank der neu patentierten Keramikzusammensetzung GLOBOTHIN®, die es ermöglicht die Stärke zu reduzieren und die Härte und den Glanz zu erhöhen.

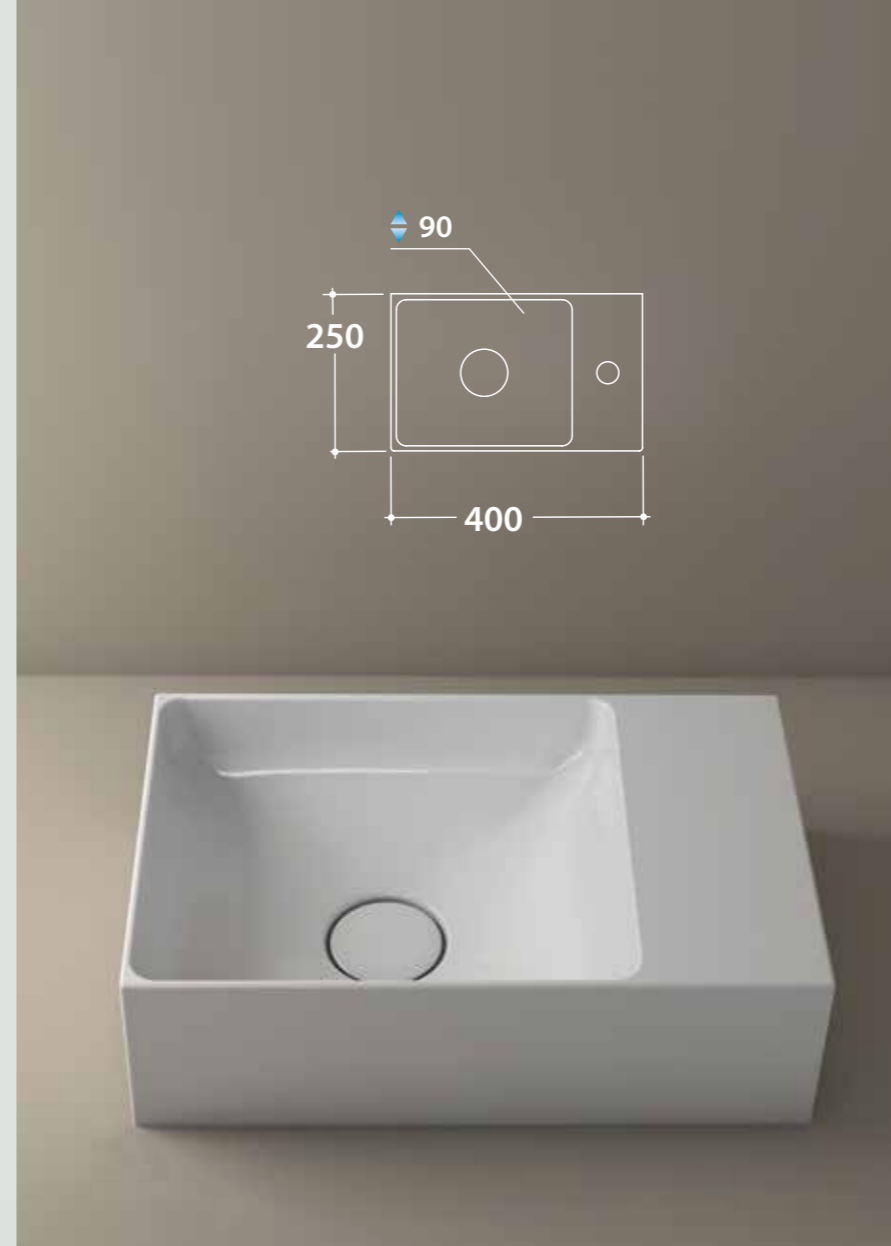

▼ B6R51AC
50.47

▲ B6R40BI
40.25

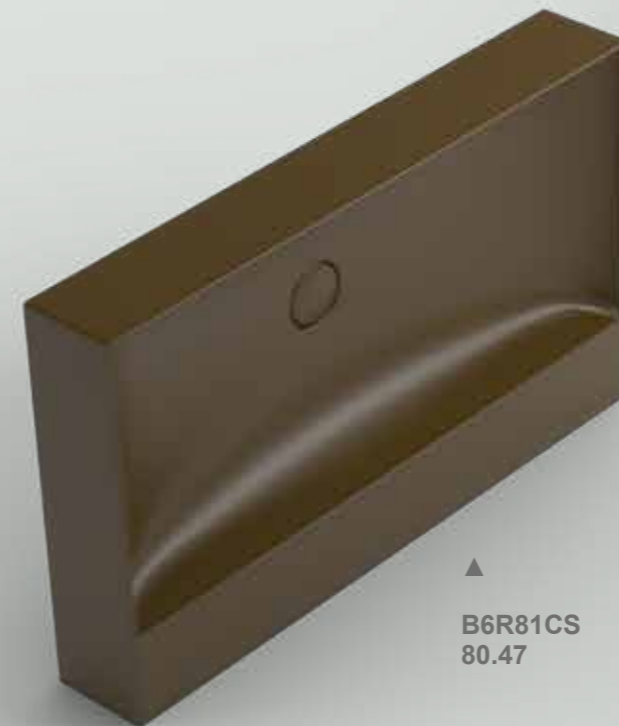

▲ B6R81CS
80.47

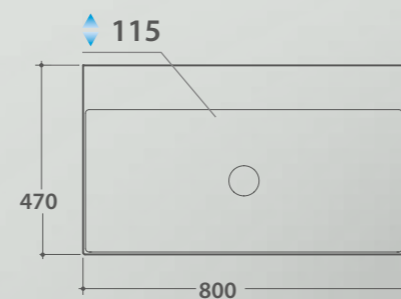
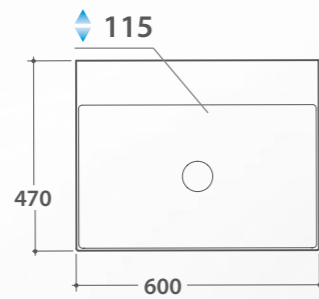
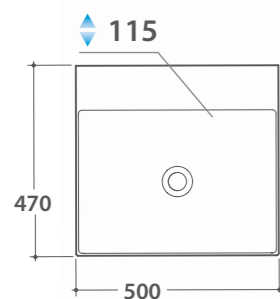

Genesis

by CreativeLab+

Genesis, come principio e creazione di ogni cosa. Forme organiche e naturali, quale incontro di linee tra spigoli arrotondati e curve morbide, a creare un design nuovo, in stile minimalista declinato al femminile. Agli elementi già presenti si aggiungono nuovi WC SENZABRIDA® e bidet nella versione sospesa e a terra dalle forme più attuali.

Genesis, like beginning and creation of everything. Organic and natural shapes, rounded and smooth, characterized by a feminine minimalist style. The elements already existing are joined by new floor and wall mounted No Rim pans and bidets in the most up-to-date shapes.

Natürlichkeit und bewusste Formgebung, abgerundet und weich, charakteristisch für ein neues minimalistisches und feminines Design. Die bereits bestehenden Elemente wurden ergänzt mit neuen wand- und bodenstehenden WCs ohne Spülrandlos und Bidets in moderner und ansprechender Form.



▼
GNS09BI
55.36

◀
GNS02BI
55.36



▲
GN009BI
55.36
BIDETMULTI®

▶
GN001BI
55.36
VASOMULTI®

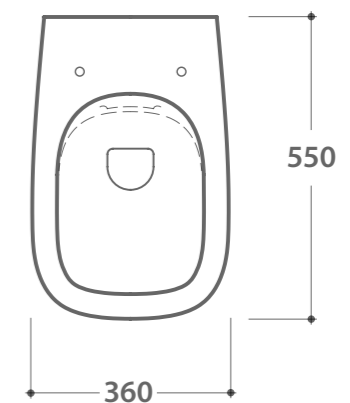
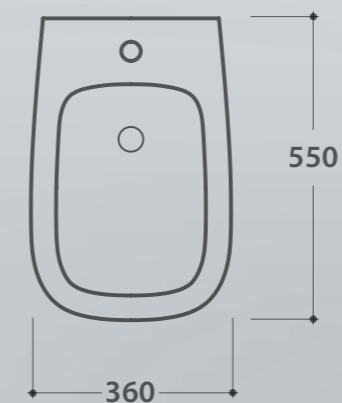

Stone

by CreativeLab+

▼
STS07BI
45.37

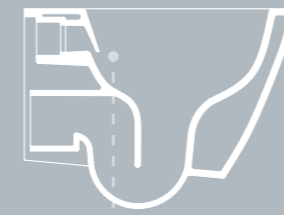
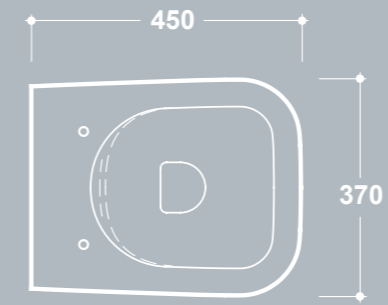

SENZABRIDA® No Rim Spülrandlos

SENZABRIDA® concentra l'uscita dell'acqua in un unico punto nella parte posteriore del vaso eliminando il bordo continuo perimetrale con vantaggi per l'igiene e la pulizia. L'acqua esce silenziosa come un velo, con un flusso circolare verso il basso e con alti livelli di performance professionale: l'uso è ideale quindi tanto nel mondo domestico quanto per il contract.

No Rim toilet bowl focuses on water flowing out in a single point at the rear of the bowl, eliminating the continuous perimeter rim to guarantee maximum hygiene and cleanliness. The water comes out silently in a circular downward flow to cover the bowl, allowing to deliver professional-level performances. This makes them ideal for both domestic and supply purposes.

Spülrandlos fokussiert den Auslauf des Spülwassers an einem Punkt auf der Innenseite des WC-Körpers. Damit wird der Spülrand vollständig entfernt und lässt wichtige hygienische Vorteile daraus entstehen. Das Wasser spült den kompletten Innenbereich des WCs kreisförmig und besonders leise aber druckvoll aus. Deshalb ist Spülrandlos sowohl für den privaten als auch für den gewerblichen Bereich besonders geeignet.



Flusso d'acqua pilotato
Piloted water flow
Gesteuerter Wasserfluss



Rumorosità ridotta
Silent
Leise



Facilità di pulizia
Easy to clean
Einfache Reinigung



Vasca esteticamente più pulita
More attractive design
große Designvielfalt



Ampia gamma
Wide range of products
Breite Palette von Produkten

Grace

by CreativeLab+

Grace, come la grazia e l'eleganza che pervade ogni elemento di questa Collezione. La morbidezza delle linee e un design contemporaneo che riporta a forme naturali viene esaltata in tutti gli articoli che la compongono. Sono diverse le novità che presenta la linea GRACE, dal nuovo Wc sospeso SENZABRIDA® e relativo bidet con fissaggi nascosti al nuovo coprivaso rimovibile con doppio profilo sottile (adatto a tutti i wc della collezione).

Grace, like the elegance characterizing every single element of this new collection. The softness of the lines and a contemporary design, reminding natural shapes, is pointed out by all the items. The GRACE line presents several new products, from the new wall-mounted No Rim pan and matching bidet with hidden fixing system to the new removable toilet seat with double thin profile (suitable for all pans of the collection).

Grace, wie Anmut und Eleganz, die alle Elemente dieser Kollektion vereinen. Die Weichheit der Linien und das zeitgenössische Design, erinnern an natürliche Formen. Diese Merkmale werden bei allen Produkten herausgehoben. Die Kollektion GRACE stellt viele neue Produkte vor, angefangen bei einem neuen wandhängendem WC, ohne Spülrand and passendem Bidet mit verborgenem Montagesystem bis hin zum abnehmbaren WC-Sitz mit dünnem Doppelprofil (für alle WC der Kollektion geeignet).



Sgancio rapido
Easy detach
Abnehmbar

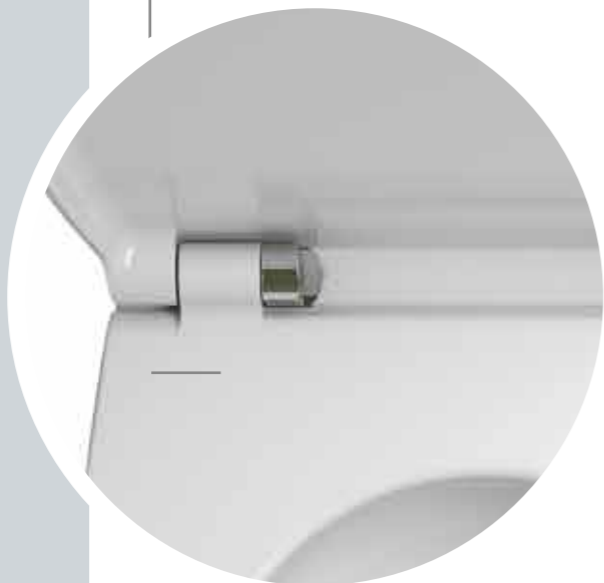
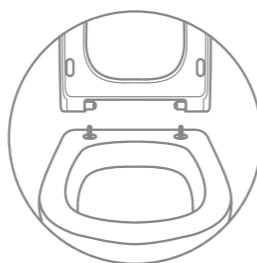

SENZABRIDA®
No rim
Spülrandlos

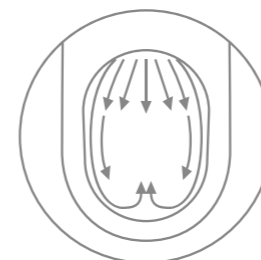

Fissaggio laterale nascosto
Lateral fixing
Seitliche Befestigung

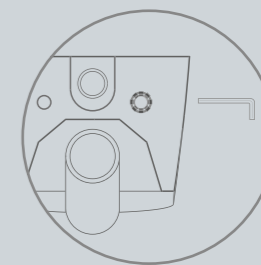

▲
GRS09BI
52.36

▼
GRS03BI
52.36

DOCCIATRE

by CreativeLab+

DT101BI
100.70

DT120BI
120.80

Grip invisibile
Invisible grip
unsichtbare Antirutsch-Beschichtung



Facilità di pulizia
Ease of cleaning
Einfache Reinigung

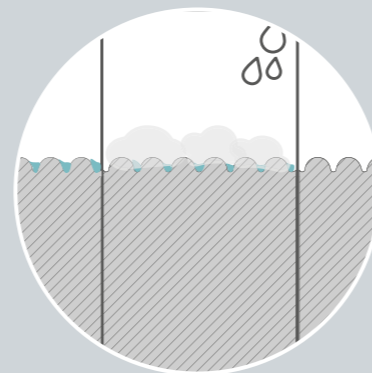

Spessore ridotto
Reduced thickness
Reduzierte Stärke

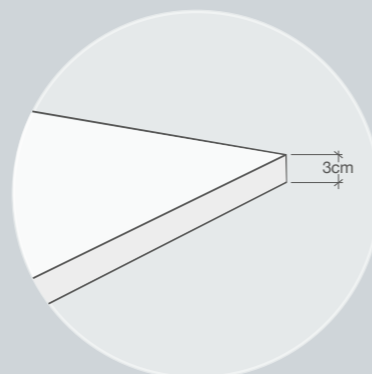

Ceramica Globo presenta Docciatre, una nuova linea di piatti doccia in ceramica alti solamente 3 cms, resistenti, sicuri e sempre brillanti come il primo giorno. Il segreto di Docciatre, disegnata da CreativeLab+, è il nuovo smalto. Applicato in modo omogeneo prima della cottura, contiene all'interno il grip WATERPASTE®, un sistema di antiscivolo, sviluppato e testato nei laboratori di ricerca dell'azienda, che garantisce una sensazione di sicurezza nella doccia e che soddisfa tutti i requisiti richiesti dalla normativa DIN51097.

Ceramica Globo presents Docciatre, a new line of highly resistant and safe ceramic shower trays with a height of only 3 cm that always remain shiny and bright even after years of use. The secret of Docciatre, designed by CreativeLab+, is the new glaze. Applied evenly before cooking, it contains WATERPASTE® grip, a non-slip system developed and tested in the company's research laboratory, which guarantees a feeling of safety in the shower and meets all the requirements of the DIN51097 standard

Ceramica Globo präsentiert die neue Serie Docciatre: Es handelt sich dabei um knapp 3 cm hohe Duschwannen, die sehr belastbar, sicher und eine hohe Haltbarkeit in Glanz und Substanz aufweisen. Das Geheimnis von Docciatre Duschwannen, die von CreativeLab+ entworfen wurden, ist die neue Glasur, die noch vor dem ersten Brennverfahren aufgetragen wird. Diese Glasur enthält die WATERPASTE(R) Rutschhemmung, entwickelt und getestet in unserem Forschungslabor, die ein gutes Gefühl der Sicherheit in der Dusche schafft und alle Anforderungen der DIN51097 erfüllt.



Nuovo modello
di griglia copripiletta

New model
of drain cover

Neues Modell von
Ablaufdeckel für
Duschwannen

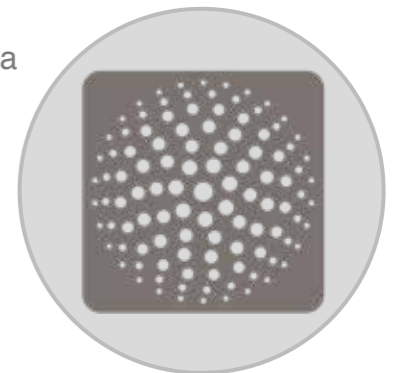

A breve disponibile !!
Available shortly !!
in Kuerze lieferbar !!





ADIMEMBER



DESIGN PLUS

Il marchio ed il logo **GLOBO**[®] sono marchi registrati.

Ceramica Globo S.p.a. diffida l'utilizzo dei propri marchi, loghi, nomi di dominio e ragione sociale anche nei Paesi in cui non sono registrati; È vietato pertanto qualsiasi utilizzo senza il consenso della Ceramica Globo S.p.a. Tutti i diritti qui non espressamente richiamati sono riservati.

Tutte le immagini contenute nel presente listino sono di proprietà di ceramica Globo.

GLOBO[®] brand and logo are registered trademarks.

Ceramica Globo S.p.a. warns to the use of their trademarks, logos, domain names and business name, even in countries where they are not registered.

It is therefore prohibited any use without the consent of Ceramica Globo Spa

All rights not expressly granted are reserved.

All images contained in this price list are CERAMICA GLOBO 's property.

*Die Marke und das Logo **GLOBO**[®] sind registrierte Marken.*

Ceramica Globo S.p.a. warnt vor der Verwendung der eigenen Marken, Logos, Name der Domains und Firmenbezeichnungen auch in Ländern in denen sie nicht registriert sind. Jegliche Nutzung ist daher ohne Genehmigung von Ceramica Globo S.p.a. verboten.

Alle nicht ausdrücklich gewährten Rechte sind vorbehalten.

follow us



CERAMICA GLOBO SPA

Loc. La Chiusa
01030 Castel Sant'Elia (VT) Italy
Tel. +(39) 0761 18731
Fax +(39) 0761 515168
www.ceramicaglobo.com
info@ceramicaglobo.com

IHR KONTAKT FÜR DEUTSCHLAND UND ÖSTERREICH:

VERTRIEBSBÜRO

T.: +49 (0) 8622 39999-0
F.: +49 (0) 8622 39999-33
Email: verkauf@ceramicaglobo.com

SHOWROOM:

Corso Monforte, 15 20122 Milano
Tel. +(39) 02 36521510
monforte15@ceramicaglobo.com

CONCEPT:

Globo Graphic Team

STAMPA:

Graphic Masters

Le tonalità dei colori sono da ritenersi indicative, in quanto possono variare in relazione alle modalità di stampa del catalogo.

The colour tones are indicative, as they may change in relation to the printing method of the catalogue.

Die Farbtöne sind Richtwerte, da sie abhängig von dem Druckverfahren des Kataloges variieren können.

www.ceramicaglobo.com